

## 38 749 Flushing System for Wall Hung Toilets

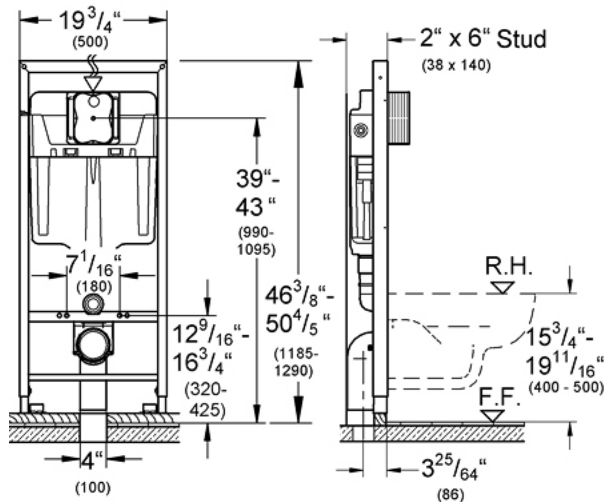

### Description

Maintenance accessible through front  
 Pre-assembled powder coated steel frame  
 3.9 ft. installation height  
 Bowl rim height adjustments 15" to 19"  
 Dual flush  
 Depth adjustable  
 Tank insulated to prevent condensation  
 1/2" Water supply connection  
 EPA WaterSense compliant (when used with EPA WaterSense approved bowl)  
 Low noise operation - meets strict European noise (DIN) standards



### Flow Rate

Dual flush - .8 gpf and 1.6 gpf (3 L and 6 L)

### Finish Options

38 749 001 Rough-In